

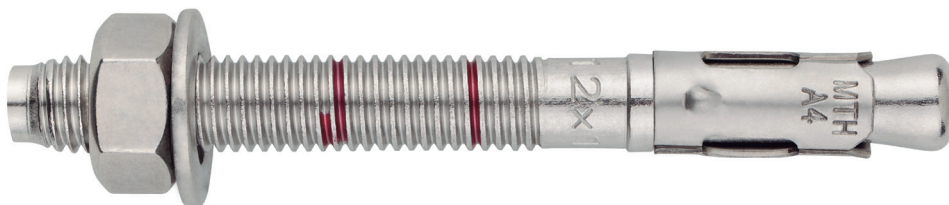

Through-bolt expansion anchor with controlled torque, for use in non cracked concrete

MTH-A4

ETA Assessed Option 7. A4 Stainless shaft. A4 Stainless clip.



PRODUCT INFORMATION

DESCRIPTION

Metallic anchor, with male thread, expansion by controlled torque.

OFFICIAL DOCUMENTATION

- AVCP-1219-CPR-0006.
- ETA 05/0242 Option 7.
- Declaration of Performance DoP MTH-A4
- MFPA Fire Protection Assessment.

SIZES

M6x45 to M20x220.

DESIGN LOAD RANGE

From 6,0 to 27,8 kN [standard depth].
From 5,0 to 8,9 kN [reduced depth].



BASE MATERIAL

Concrete class from C20/25 to C50/60 non-cracked.



Stone

Concrete

Reinforced concrete

ASSESSMENTS

- Option 7 (non-cracked concrete).



05
Técnicas Expansivas S.L.
Segador 13. Logroño. Spain
ETA 05/0242
1219
Structural fixings in non
cracked concrete

**FIRE**
RESISTANCE

CHARACTERISTICS AND BENEFITS

- Easy installation.
- Use in non-cracked concrete.
- Use for medium-heavy duty loads.
- Pre-installation or through the drill-hole of the fixture.
- Variety of lengths and diameters: flexibility in assembly.
- For static and quasi-static loads.
- Two installation depths in M8, M10 and M12 allowing the use in thick anchor plates or in low thickness base materials.
- Available at INDEXcal.
- Version in A4 Stainless steel [AISI 316].
- Available at INDEXcal.



MATERIALS

Shaft: A4 grade stainless steel.

Washer: A4 grade stainless steel.

Nut: A4 grade stainless steel.

Clip: A4 grade stainless steel.



APPLICATIONS

- Coastal areas.
- Industrial areas.
- Food industries.
- Curtain walls.
- Fixings in tunnels.
- Pipe supports.
- Rehabilitation of facades.
- For outdoor use in general.

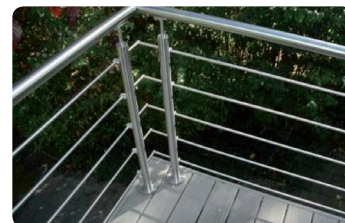



MECHANICAL PROPERTIES

			M6	M8	M10	M12	M16	M20
Cone area section								
A_s	(mm ²)	Cone area section	14,5	27,3	49,0	70,9	122,7	201,1
$f_{u,s}$	(N/mm ²)	Characteristic tension resistance	700	700	700	700	700	700
$f_{y,s}$	(N/mm ²)	Yield strength	500	500	500	500	500	500
Threaded area section								
A_s	(mm ²)	Cone area section	20.1	36.6	58.0	84.3	157.0	245.0
$f_{u,s}$	(N/mm ²)	Characteristic tension resistance	600	600	600	600	600	600
$f_{y,s}$	(N/mm ²)	Yield Strength	400	400	400	400	400	400

INSTALLATION DATA

SIZE			M6	M8	M10	M12	M16	M20	
Code			MIA406XXX	MIA408XXX	MIA410XXX	MIA412XXX	MIA416XXX	MIA420XXX	
d_0	Nominal diameter of drill bit	[mm]	6	8	10	12	16	20	
T_{ins}	Installation torque moment	[Nm]	7	20	35	60	120	240	
$d_{f \leq}$	Diameter of clearance hole in the fixture	[mm]	7	9	12	14	18	22	
Standard depth	h_1	Minimum drill hole depth	[mm]	55	65	75	85	110	135
	h_{nom}	Installation depth	[mm]	49,5	59,5	66,5	77	103,5	125
	h_{ef}	Effective embedment depth	[mm]	40	48	55	65	84	103
	h_{min}	Minimum base material thickness	[mm]	100	100	110	130	168	206
	t_{fix}	Maximum thickness of fixture*	[mm]	L - 58	L - 70	L - 80	L - 92	L - 122	L - 147
	$s_{cr,N}$	Critical spacing	[mm]	120	144	165	195	252	309
	$c_{cr,N}$	Critical edge distance	[mm]	60	72	83	98	126	155
	$s_{cr,sp}$	Critical distance (splitting)	[mm]	160	192	220	260	336	412
	$c_{cr,sp}$	Critical edge distance (splitting)	[mm]	80	96	110	130	168	206
	Reduced depth	h_1	Minimum drill hole depth	[mm]	-	50	60	70	-
h_{nom}		Installation depth	[mm]	-	46,5	53,5	62	-	-
h_{ef}		Effective embedment depth	[mm]	-	35	42	50	-	-
h_{min}		Minimum base material thickness	[mm]	-	100	100	100	-	-
t_{fix}		Maximum thickness of fixture*	[mm]	-	L-57	L-67	L-77	-	-
$s_{cr,N}$		Critical spacing	[mm]	-	105	126	150	-	-
$c_{cr,N}$		Critical edge distance	[mm]	-	53	63	75	-	-
$s_{cr,sp}$		Critical distance (splitting)	[mm]	-	140	168	200	-	-
$c_{cr,sp}$		Critical edge distance (splitting)	[mm]	-	70	84	100	-	-
s_{min}		Minimum spacing	[mm]	50	65	70	85	110	135
c_{min}	Minimum edge distance	[mm]	50	65	70	85	110	135	
SW	Installation wrench		10	13	17	19	24	30	

*L = Total anchor length

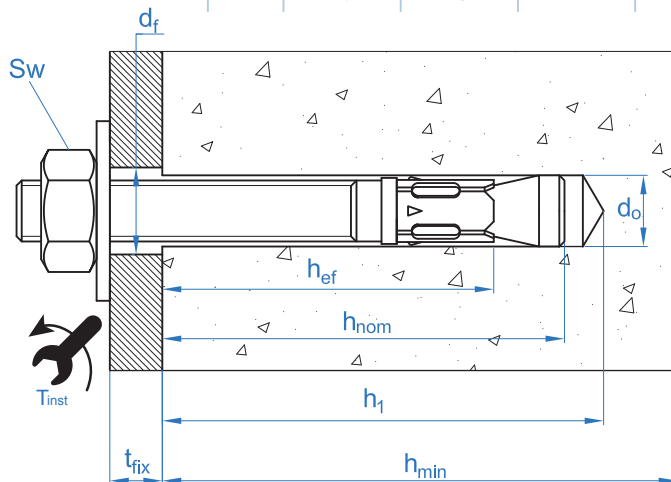



Code	INSTALLATION PRODUCTS
	Hammer drill
BHDSXXXXX	Concrete Drill bits
MOBOMBA	Blow pump
MORCEPKIT	Cleaning Brush
DOMTAXX	Installation hammering tool
	Torque wrench
	Hexagonal socket

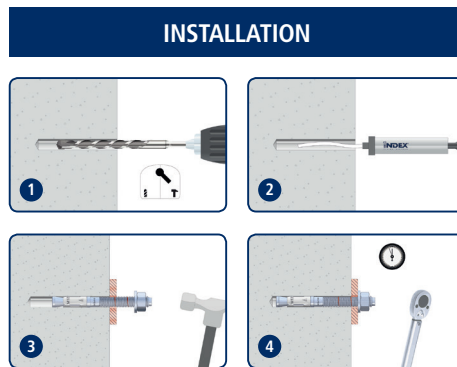

MTH-A4

Resistances in C20/25 concrete for an isolated anchor, without effects of edge distance or spacing

Characteristic Resistance N_{Rk} y V_{Rk}																	
TENSION								SHEAR									
Size		M6	M8	M10	M12	M16	M20	Size		M6	M8	M10	M12	M16	M20		
N_{Rk}	Standard depth	[kN]	10,1	12	16	25	35	50	V_{Rk}	Standard depth	[kN]	6,0	10,9	17,4	25,2	47,1	73,5
N_{Rk}	Reduced depth	[kN]	-	9	12	16	-	-	V_{Rk}	Reduced depth	[kN]	-	10,4	13,7	17,8	-	-

Design Resistance N_{Rd} y V_{Rd}																	
TENSION								SHEAR									
Size		M6	M8	M10	M12	M16	M20	Size		M6	M8	M10	M12	M16	M20		
N_{Rd}	Standard depth	[kN]	6,0	8,0	8,9	13,9	19,4	27,8	V_{Rd}	Standard depth	[kN]	3,9	7,1	11,4	16,6	30,1	48,3
N_{Rd}	Reduced depth	[kN]	-	5,0	6,7	8,9	-	-	V_{Rd}	Reduced depth	[kN]	-	7,0	9,1	11,9	-	-

Maximum Loads Recommended N_{rec} y V_{rec}																	
TENSION								SHEAR									
Size		M6	M8	M10	M12	M16	M20	Size		M6	M8	M10	M12	M16	M20		
N_{rec}	Standard depth	[kN]	4,3	5,7	6,3	9,9	13,9	19,8	V_{rec}	Standard depth	[kN]	2,8	5,1	8,2	11,8	22,1	34,5
N_{rec}	Reduced depth	[kN]	-	3,6	4,8	6,4	-	-	V_{rec}	Reduced depth	[kN]	-	4,9	6,5	8,5	-	-

Simplified calculation method

European Technical Assessment ETA 05/0242

Simplified version of the calculation method according to ETAG 001, annex C. Resistance is calculated according to the data shown in assessment ETA 05/0242.

- Influence of concrete strength.
- Influence of edge distance.
- Influence of spacing between anchors.
- Influence of reinforcements.
- Influence of base material thickness.
- Influence of load application angle.
- Valid for a group of two anchors.

The calculation method is based on the following simplification: **Different loads do not act on individual anchors, without eccentricity.**



INDEXcal

For a more accurate calculation and to take more constructive provisions into account, we recommend using our calculation program INDEXcal. It may be easily downloaded from our website www.indexfix.com

MTH-A4

TENSION LOADS

- Steel design resistance: $N_{Rd,s}$
- Pull-out design resistance: $N_{Rd,p} = N_{Rd,p}^o \cdot \psi_c$
- Concrete cone design resistance: $N_{Rd,c} = N_{Rd,c}^o \cdot \psi_b \cdot \psi_{s,N} \cdot \psi_{c,N} \cdot \psi_{re,N}$
- Concrete splitting design resistance: $N_{Rd,sp} = N_{Rd,c}^o \cdot \psi_b \cdot \psi_{s,sp} \cdot \psi_{c,sp} \cdot \psi_{re,N} \cdot \psi_{h,sp}$

Steel Design resistance								
$N_{Rd,s}$								
Size			M6	M8	M10	M12	M16	M20
N_{Rd}^o	Standard depth	[kN]	6,0	11,4	20,4	29,5	51,1	83,8

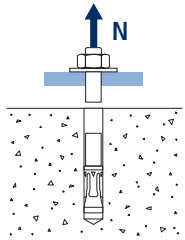

Pull-out design resistance								
$N_{Rd,p} = N_{Rd,p}^o \cdot \psi_c$								
Size			M6	M8	M10	M12	M16	M20
$N_{Rd,p}^o$	Standard depth	[kN]	-*	8,0	8,9	13,9	19,4	27,8
$N_{Rd,p}^o$	Reduced depth	[kN]	-	5,0	6,7	8,9	-	-

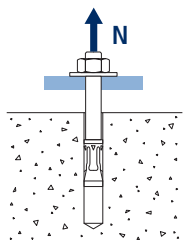

* Pull-out failure is not decisive.

Concrete cone design resistance								
$N_{Rd,c} = N_{Rd,c}^o \cdot \psi_b \cdot \psi_{s,N} \cdot \psi_{c,N} \cdot \psi_{re,N}$								
Concrete splitting design resistance*								
$N_{Rd,sp} = N_{Rd,c}^o \cdot \psi_b \cdot \psi_{s,sp} \cdot \psi_{c,sp} \cdot \psi_{re,N} \cdot \psi_{h,sp}$								
Size			M6	M8	M10	M12	M16	M20
$N_{Rd,c}^o$	Standard depth	[kN]	8,5	11,2	11,4	14,7	21,6	29,3
$N_{Rd,c}^o$	Reduced depth	[kN]	-	5,8	7,6	9,9	-	-

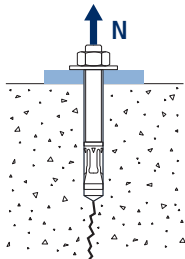
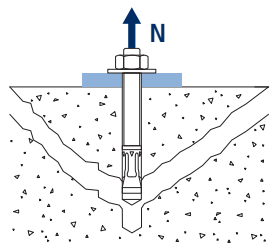

* Concrete splitting design resistance must only be considered for non-cracked concrete.

**MTH-A4**

Coefficients of influence

Influence of concrete strength resistance in pul-out failure ψ_c

		M6	M8	M10	M12	M16	M20	
ψ_c	C 20/25	1,00						
	C 30/37	1,22						
	C 40/50	1,41						
	C 50/60	1,55						

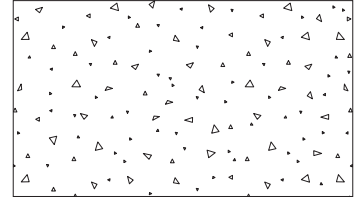
Influence of concrete strength in concret cone and splitting failure ψ_b

		M6	M8	M10	M12	M16	M20	
ψ_b	C 20/25	1,00						
	C 30/37	1,22						
	C 40/50	1,41						
	C 50/60	1,55						

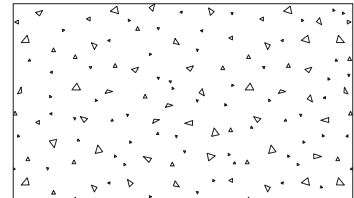

$$\psi_b = \sqrt{\frac{f_{ck,cube}}{25}} \geq 1$$



MTH-A4

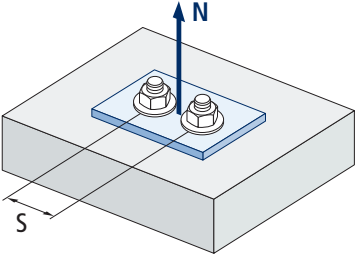

$$\psi_{s,N} = 0,5 + \frac{s}{2 \cdot s_{cr,N}} \leq 1$$

Influence of spacing (concrete cone) $\psi_{s,N}$						
s [mm]	MTH-A4. Standard depth					
	M6	M8	M10	M12	M16	M20
50	0,71					
55	0,73					
60	0,75					
65	0,77	0,73				
70	0,79	0,74	0,71			
80	0,83	0,78	0,74			
85	0,85	0,80	0,76	0,72		
90	0,88	0,81	0,77	0,73		
100	0,92	0,85	0,80	0,76		
105	0,94	0,86	0,82	0,77		
110	0,96	0,88	0,83	0,78	0,72	
120	1,00	0,92	0,86	0,81	0,74	
125		0,93	0,88	0,82	0,75	
126		0,94	0,88	0,82	0,75	
128		0,94	0,89	0,83	0,75	
130		0,95	0,89	0,83	0,76	
135		0,97	0,91	0,85	0,77	0,72
144		1,00	0,94	0,87	0,79	0,73
150			0,95	0,88	0,80	0,74
165			1,00	0,92	0,83	0,77
170				0,94	0,84	0,78
180				0,96	0,86	0,79
195				1,00	0,89	0,82
200					0,90	0,82
210					0,92	0,84
220					0,94	0,86
225					0,95	0,86
252					1,00	0,91
255						0,91
260						0,92
300						0,99
309						1,00

MTH-A4. Reduced depth						
s [mm]	MTH-A4. Reduced depth					
	M6	M8	M10	M12	M16	M20
65		0,81				
70		0,83	0,78			
80		0,88	0,82			
85		0,90	0,84	0,78		
90		0,93	0,86	0,80		
100		0,98	0,90	0,83		
105		1,00	0,92	0,85		
110			0,94	0,87		
120			0,98	0,90		
125			1,00	0,92		
126			1,00	0,92		
128				0,93		
130				0,93		
135				0,95		
144				0,98		
150				1,00		



Influence of spacing (concrete splitting) $\psi_{s,sp}$						
s [mm]	MTH-A4. Standard depth					
	M6	M8	M10	M12	M16	M20
50	0,66					
55	0,67					
60	0,69					
65	0,70	0,67				
70	0,72	0,68	0,66			
80	0,75	0,71	0,68			
85	0,77	0,72	0,69	0,66		
90	0,78	0,73	0,70	0,67		
100	0,81	0,76	0,73	0,69		
110	0,84	0,79	0,75	0,71	0,66	
125	0,89	0,83	0,78	0,74	0,69	
128	0,90	0,83	0,79	0,75	0,69	
135	0,92	0,85	0,81	0,76	0,70	0,66
140	0,94	0,86	0,82	0,77	0,71	0,67
150	0,97	0,89	0,84	0,79	0,72	0,68
160	1,00	0,92	0,86	0,81	0,74	0,69
165		0,93	0,88	0,82	0,75	0,70
168		0,94	0,88	0,82	0,75	0,70
180		0,97	0,91	0,85	0,77	0,72
192		1,00	0,94	0,87	0,79	0,73
200			0,95	0,88	0,80	0,74
210			0,98	0,90	0,81	0,75
220			1,00	0,92	0,83	0,77
260				1,00	0,89	0,82
288					0,93	0,85
300					0,95	0,86
336					1,00	0,91
350						0,92
412						1,00

MTH-A4

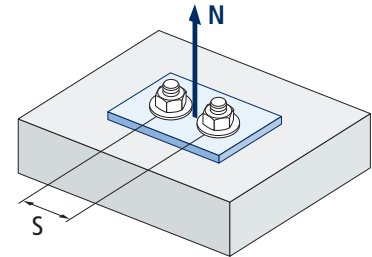

$$\psi_{s,sp} = 0,5 + \frac{s}{2 \cdot s_{cr,sp}} \leq 1$$

s [mm]	MTH-A4. Reduced depth					
	M6	M8	M10	M12	M16	M20
65		0,73				
70		0,75	0,71			
80		0,79	0,74			
85		0,80	0,75	0,71		
90		0,82	0,77	0,73		
100		0,86	0,80	0,75		
110		0,89	0,83	0,78		
125		0,95	0,87	0,81		
128		0,96	0,88	0,82		
135		0,98	0,90	0,84		
140		1,00	0,92	0,85		
150			0,95	0,88		
160			0,98	0,90		
165			0,99	0,91		
168			1,00	0,92		
180				0,95		
192				0,98		
200				1,00		



MTH-A4

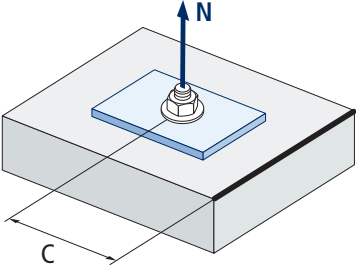

$$\Psi_{c,sp} = 0,35 + \frac{0,5 \cdot c}{C_{cr,sp}} + \frac{0,15 \cdot c^2}{C_{cr,sp}^2} \leq 1$$

Influence of concrete edge distance (splitting) $\Psi_{c,sp}$						
c [mm]	MTH-A4. Standard depth					
	M6	M8	M10	M12	M16	M20
50	0,72					
60	0,81					
65	0,86	0,76				Invalid value
70	0,90	0,79	0,73			
75	0,95	0,83	0,76			
80	1,00	0,87	0,79			
83		0,89	0,81			
84		0,90	0,82			
85		0,91	0,83	0,74		
90		0,95	0,86	0,77		
96		1,00	0,90	0,80		
100			0,93	0,82		
105			0,96	0,85		
110			1,00	0,88	0,74	
125				0,97	0,81	
128				0,99	0,82	
130				1,00	0,83	
135					0,85	0,74
144					0,89	0,77
150					0,92	0,79
168					1,00	0,86
175						0,88
180						0,90
206						1,00

c [mm]	MTH-A4. Reduced depth					
	M6	M8	M10	M12	M16	M20
50		0,78				
60		0,89	0,78			
65		0,94	0,83			Invalid value
70		1,00	0,87			
75			0,92			
80			0,96			
83			0,99	0,87		
84			1,00	0,88		
85				0,88		
90				0,92		
96				0,97		
100				1,00		



Influence of concrete edge distance (concrete cone) $\psi_{c,N}$						
c [mm]	MTH-A4. Standard depth					
	M6	M8	M10	M12	M16	M20
50	0,87					
53	0,91					
60	1,00					
63						
65		0,92				
70		0,98	0,88			
72		1,00	0,90			
75			0,92			
80			0,97			
83			1,00			
85				0,90		
90				0,94		
98				1,00		
100						
105						
110					0,90	
113					0,92	
125					0,99	
126					1,00	
128						
135						0,90
150						0,97
155						1,00

MTH-A4. Reduced depth						
c [mm]	M6	M8	M10	M12	M16	M20
	65		1,00			
70			1,00			
72						
75						
80						
83						
85				1,00		

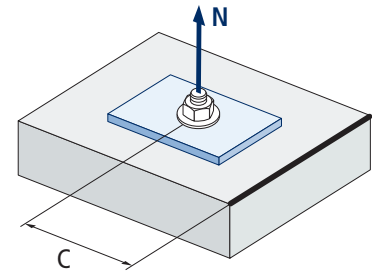
MTH-A4

$$\psi_{c,N} = 0,35 + \frac{0,5 \cdot c}{C_{cr,N}} + \frac{0,15 \cdot c^2}{C_{cr,N}^2} \leq 1$$



MTH-A4

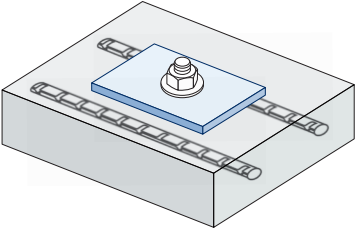

$$\Psi_{re,N} = 0,5 + \frac{h_{ef}}{200} \leq 1$$

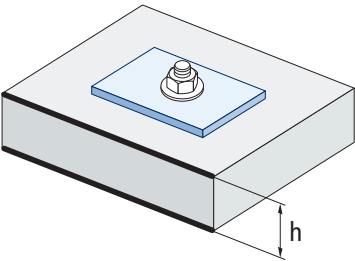

Influence of reinforcements $\Psi_{re,N}$						
$\Psi_{re,N}$	MTH-A4. Standard depth					
	M6	M8	M10	M12	M16	M20
	0,70	0,74	0,77	0,82	0,92	1,00
	MTH-A4. Reduced depth					
	M6	M8	M10	M12	M16	M20
	-	0,67	0,71	0,75	-	-

*This factor only applies for a high density of reinforcements. If in the area of the anchor there are reinforcements with a distancing of ≥ 150 mm (any diameter) or with a diameter ≤ 10 mm and a distancing of ≥ 100 mm, a $f_{re,N} = 1$ factor may be applied.

Influence of base material thickness $\Psi_{h,sp}$										
$\Psi_{h,sp}$	MTH-A4									
	h/h _{ef}	2,00	2,20	2,40	2,60	2,80	3,00	3,20	3,40	3,60
$\Psi_{h,sp}$	1,00	1,07	1,13	1,19	1,25	1,31	1,37	1,42	1,48	1,50

$$\Psi_{h,sp} = \left(\frac{h}{2 \cdot h_{ef}} \right)^{2/3} \leq 1,5$$

Shear Loads

- Steel design resistance without lever arm: $V_{Rd,s}$
- Pry-out design resistance: $V_{Rd,cp} = k \cdot N_{Rd,c}^o$
- Concrete edge design resistance: $V_{Rd,c} = V_{Rd,c}^o \cdot \Psi_b \cdot \Psi_{se,V} \cdot \Psi_{c,V} \cdot \Psi_{re,V} \cdot \Psi_{\alpha,V} \cdot \Psi_{h,V}$

Steel design resistance								
$V_{Rd,s}$								
	Size		M6	M8	M10	M12	M16	M20
$V_{Rd,s}$	Standard depth	[kN]	3,9	7,2	11,4	16,6	31,0	48,4
$V_{Rd,s}$	Reduced depth	[kN]	-	7,2	11,4	16,6	-	-

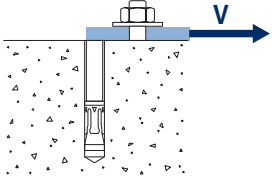

Pry-out design resistance*								
$V_{Rd,cp} = k \cdot N_{Rd,c}^o$								
	Size		M6	M8	M10	M12	M16	M20
	k (Standard depth)		1	1	1	2	2	2
	k (Reduced depth)		-	1	1	1	-	-

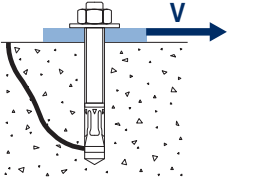

* $N_{Rd,c}^o$ Concrete cone design resistance for tension loads

Concrete edge resistance								
$V_{Rd,c} = V_{Rd,c}^o \cdot \Psi_b \cdot \Psi_{se,V} \cdot \Psi_{c,V} \cdot \Psi_{re,V} \cdot \Psi_{\alpha,V} \cdot \Psi_{h,V}$								
	Size		M6	M8	M10	M12	M16	M20
$V_{Rd,c}^o$	Standard depth	[kN]	4,6	6,2	7,7	10,2	15,6	21,8
$V_{Rd,c}^o$	Reduced depth	[kN]	-	3,7	4,9	6,6	-	-

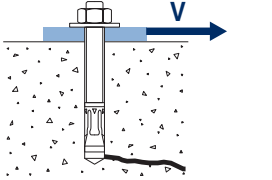



MTH-A4

Coefficients of influence

Influence of concrete strength in concrete edge failure Ψ_b

		M6	M8	M10	M12	M16	M20	
Ψ_b	C 20/25	1,00						
	C 30/37	1,22						
	C 40/50	1,41						
	C 50/60	1,55						



$$\Psi_b = \sqrt{\frac{f_{ck,cube}}{25}} \geq 1$$

Influence of edge distance and spacing $\Psi_{se,V}$

FOR ONE ANCHOR ONLY

c/h_{ef}	0,50	0,75	1,00	1,25	1,50	1,75	2,00	2,25	2,50	2,75	3,00	3,25	3,50	3,75	4,00	4,50	5,00
Isolated	0,35	0,65	1,00	1,40	1,84	2,32	2,83	3,38	3,95	4,56	5,20	5,86	6,55	7,26	8,00	9,55	11,18

FOR TWO ANCHORS

c/h_{ef}	0,50	0,75	1,00	1,25	1,50	1,75	2,00	2,25	2,50	2,75	3,00	3,25	3,50	3,75	4,00	4,50	5,00	
s/c	1,0	0,24	0,43	0,67	0,93	1,22	1,54	1,89	2,25	2,64	3,04	3,46	3,91	4,37	4,84	5,33	6,36	7,45
	1,5	0,27	0,49	0,75	1,05	1,38	1,74	2,12	2,53	2,96	3,42	3,90	4,39	4,91	5,45	6,00	7,16	8,39
	2,0	0,29	0,54	0,83	1,16	1,53	1,93	2,36	2,81	3,29	3,80	4,33	4,88	5,46	6,05	6,67	7,95	9,32
	2,5	0,32	0,60	0,92	1,28	1,68	2,12	2,59	3,09	3,62	4,18	4,76	5,37	6,00	6,66	7,33	8,75	10,25
	≥3,0	0,35	0,65	1,00	1,40	1,84	2,32	2,83	3,38	3,95	4,56	5,20	5,86	6,55	7,26	8,00	9,55	11,18

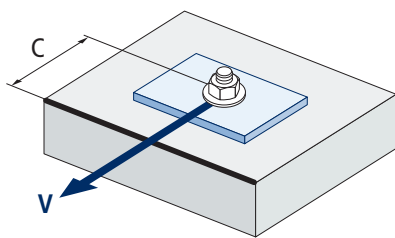

$$\Psi_{se,V} = \left(\frac{c}{h_{ef}}\right)^{1,5}$$

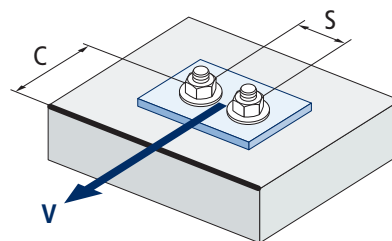

$$\Psi_{se,V} = \left(\frac{c}{h_{ef}}\right)^{1,5} \cdot \left(1 + \frac{s}{3 \cdot c}\right) \cdot 0,5 \leq \left(\frac{c}{h_{ef}}\right)^{1,5}$$



MTH-A4

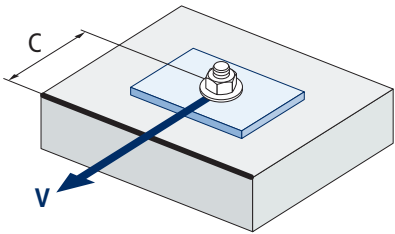

$$\psi_{c,v} = \left(\frac{d}{c} \right)^{0,20}$$

Influence of concrete edge distance $\psi_{c,v}$						
c [mm]	MTH-A4					
	M6	M10	M10	M12	M16	M20
40						
45						
50	0,65					
55	0,64					
60	0,63					
65	0,62	0,66				
70	0,61	0,65	0,68			
80	0,60	0,63	0,66			
85	0,59	0,62	0,65	0,68		
90	0,58	0,62	0,64	0,67		
100	0,57	0,60	0,63	0,65	0,67	
105	0,56	0,60	0,62	0,65	0,67	
110	0,56	0,59	0,62	0,64	0,66	0,68
120	0,55	0,58	0,61	0,63	0,65	0,67
125	0,54	0,58	0,60	0,63	0,65	0,66
130	0,54	0,57	0,60	0,62	0,64	0,66
135	0,54	0,57	0,59	0,62	0,64	0,65
140	0,53	0,56	0,59	0,61	0,63	0,65
150	0,53	0,56	0,58	0,60	0,62	0,64
160	0,52	0,55	0,57	0,60	0,61	0,63
170	0,51	0,54	0,57	0,59	0,61	0,62
175	0,51	0,54	0,56	0,59	0,60	0,62
180	0,51	0,54	0,56	0,58	0,60	0,62
190	0,50	0,53	0,55	0,58	0,59	0,61
200	0,50	0,53	0,55	0,57	0,59	0,60
210	0,49	0,52	0,54	0,56	0,58	0,60
220	0,49	0,52	0,54	0,56	0,58	0,59
230	0,48	0,51	0,53	0,55	0,57	0,59
240	0,48	0,51	0,53	0,55	0,57	0,58
250	0,47	0,50	0,53	0,54	0,56	0,58
260	0,47	0,50	0,52	0,54	0,56	0,57
270	0,47	0,49	0,52	0,54	0,55	0,57
280	0,46	0,49	0,51	0,53	0,55	0,56
290	0,46	0,49	0,51	0,53	0,55	0,56
300	0,46	0,48	0,51	0,53	0,54	0,56



Influence of reinforcements $\Psi_{re,v}$			
	Without perimetral reinforcements	Perimetral reinforcements $\geq \text{Ø}12 \text{ mm}$	Perimetral reinforcements with brackets $\leq 100 \text{ mm}$
Non-cracked concrete	1	1	1

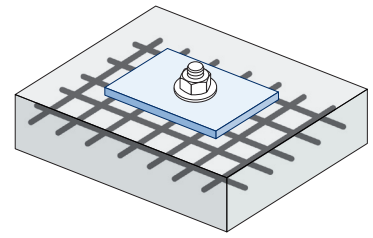

Influence of load application angle $\Psi_{\alpha,v}$										
Angle, $\alpha(^{\circ})$	0°	10°	20°	30°	40°	50°	60°	70°	80°	90°
$\Psi_{\alpha,v}$	1,00	1,01	1,05	1,13	1,24	1,40	1,64	1,97	2,32	2,50

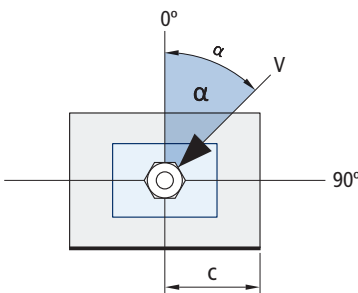

$$\Psi_{\alpha,v} = \sqrt{\frac{1}{(\cos \alpha_v)^2 + \left(\frac{\sin \alpha_v}{2,5}\right)^2}} \geq 1$$

Influence of base material thickness $\Psi_{h,v}$										
MTH-A4										
h/c	0,15	0,30	0,45	0,60	0,75	0,90	1,05	1,20	1,35	$\geq 1,5$
$\Psi_{h,v}$	0,32	0,45	0,55	0,63	0,71	0,77	0,84	0,89	0,95	1,00

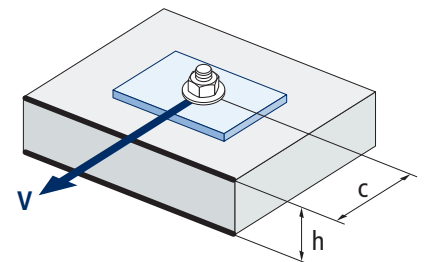

$$\Psi_{h,v} = \left(\frac{h}{1,5 \cdot c}\right)^{0,5} \geq 1,0$$



MTH-A4

FIRE RESISTANCE

Characteristic Resistance*												
	TENSION						SHEAR					
	M6	M8	M10	M12	M16	M20	M6	M8	M10	M12	M16	M20
RF30	-	0,8	1,5	2,4	4,5	7,0	-	0,8	1,5	2,4	4,5	7,0
RF60	-	0,7	1,2	2,0	3,6	5,7	-	0,7	1,2	2,0	3,6	5,7
RF90	-	0,5	1,0	1,5	2,7	4,3	-	0,5	1,0	1,5	2,7	4,3
RF120	-	0,5	0,8	1,2	2,3	3,6	-	0,5	0,8	1,2	2,3	3,6

*The safety factor for design resistance under fire exposure is $\gamma_{M,fi}=1$ (in absence of other national regulations). As a result the Characteristic Resistance is the same as Design Resistance.

Maximum Load Recommended												
	TENSION						SHEAR					
	M6	M8	M10	M12	M16	M20	M6	M8	M10	M12	M16	M20
RF30	-	0,6	1,1	1,7	3,2	5,0	-	0,6	1,1	1,7	3,2	5,0
RF60	-	0,5	0,9	1,4	2,6	4,0	-	0,5	0,9	1,4	2,6	4,0
RF90	-	0,4	0,7	1,1	2,0	3,1	-	0,4	0,7	1,1	2,0	3,1
RF120	-	0,3	0,6	0,9	1,6	2,6	-	0,3	0,6	0,9	1,6	2,6

• Fire resistance values are not covered by ETA.

RANGE

Code	Size	Maximum thickness of fixture	Axle letter (length)			Code	Size	Maximum thickness of fixture	Axle letter (length)		
• MIA406045	M6 x 45 Ø6	1	A	200	1.200	• MIA412075	M12 x 75 Ø12	5	C	50	300
MIA406060	M6 x 60 Ø6	2	B	200	1.200	MIA412090	M12 x 90 Ø12	13	D	50	200
MIA406080	M6 x 80 Ø6	22	D	200	1.200	MIA412110	M12 x 110 Ø12	12	F	50	200
• MIA408050	M8 x 50 Ø8	4	A	100	800	MIA412140	M12 x 140 Ø12	42	I	50	200
MIA408075	M8 x 75 Ø8	5	C	100	600	• MIA416090	M16 x 90 Ø16	4	D	25	150
MIA408090	M8 x 90 Ø8	20	E	100	600	MIA416145	M16 x 145 Ø16	23	I	25	100
MIA408115	M8 x 115 Ø8	45	G	100	400	MIA416170	M16 x 170 Ø16	48	K	25	75
MIA410070	M10 x 70 Ø10	3	C	100	400	• MIA420120	M20 x 120 Ø20	5	G	20	80
MIA410090	M10 x 90 Ø10	10	E	100	400	MIA420170	M20 x 170 Ø20	23	K	20	80
MIA410120	M10 x 120 Ø10	40	G	50	300	MIA420220	M20 x 220 Ø20	73	O	20	60
MIA410150	M10 x 150 Ø10	70	I	50	200						

• Non assessed sizes. Resistance values and installation data are not applicable to these references. For further information, please contact Technical Department.